

动刀座连接方式

TYPE OF COUPLING

DIN 5480

VDI	A	B	D	Z
30	67	55	15,8	18
40	75	63	19,8	24
50	93	78	23,8	18

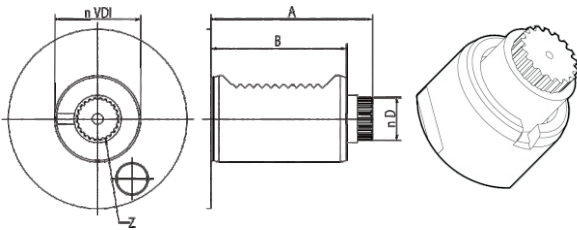

DIN 5482

VDI	A	B	D	E	Z
30	55	45	14,5	B15X12	8
40	63	53	16,5	B17X14	9
50	93	78	19,5	B20X17	11

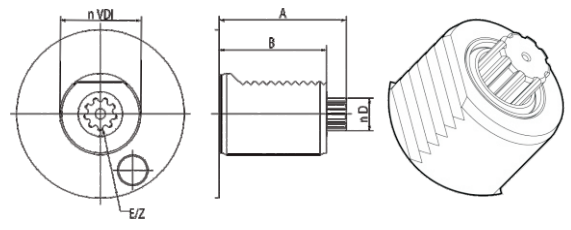

DIN 1809

VDI	A	B	C	D	E
30	62	45	8	12	6
40	72	53	10	18	8
50	91	78	13	24	13

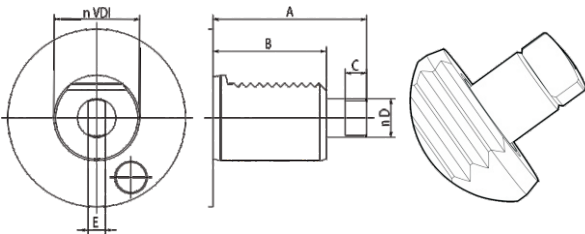

TOEM BARUFFALDI

VDI	A	B	D	Z
30	59	45/53	24	6
40	68	53	32	8
50	84	70	40	8

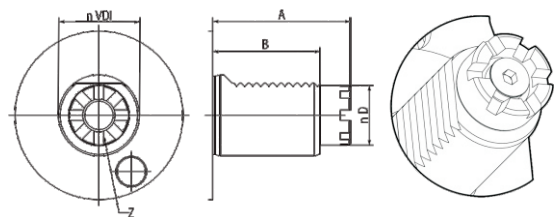

主轴逆时针旋转

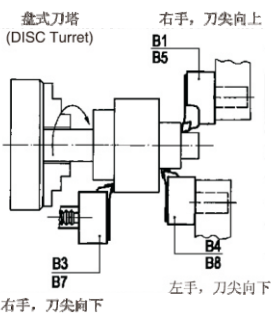

主轴顺时针旋转

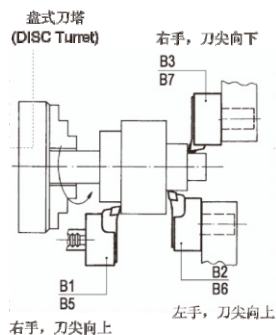

主轴逆时针旋转

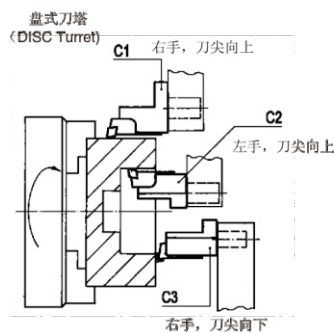

主轴顺时针旋转

