

MorseTaper With Drawbar Thread Toolholder / BT-带螺纹孔莫氏刀柄

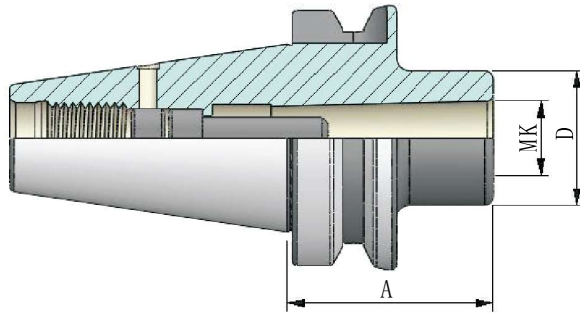











G6.3 12,000min⁻¹

≤ 0.005

DIN 6364

BT-带螺孔莫氏刀柄

Order No. 货号	Size 规格	MK 莫氏锥度	D 外径	Cooling 冷却方式	A 有效长度
41.3101.45	BT40-MTB1-45	MK1	25	A	45 
41.3102.60	BT40-MTB2-50	MK2	32	A	60 
41.3103.75	BT40-MTB3-75	MK3	40	A	75 
41.3103.90	BT40-MTB3-90	MK3	40	A	90 
41.3104.100	BT40-MTB4-100	MK4	48	A	100 
51.3101.45	BT50-MTB1-45	MK1	25	A	45 
51.3102.60	BT50-MTB2-60	MK2	32	A	60 
51.3103.60	BT50-MTB3-60	MK3	40	A	60 
51.3103.75	BT50-MTB3-75	MK3	40	A	75 
51.3104.100	BT50-MTB4-100	MK4	48	A	100 
51.3105.120	BT50-MTB5-120	MK5	63	A	120 